

# IEA Solar Heating & Cooling Programme

2

0

0

7

## TABLE OF CONTENTS

- 3 Note from the Chairman
- 4 Advanced Storage Concepts for Solar and Low Energy Buildings
- 7 Solar Heat for Industrial Processes
- 10 Testing and Validation of Building Energy Simulation Tools
- 12 PV/Thermal Solar Systems
- 14 Solar Resource Knowledge Management
- 16 Advanced Housing Renovation with Solar and Conservation
- 18 Solar Air-Conditioning and Refrigeration
- 20 Polymeric Materials for Solar Thermal Applications
- 22 Net Zero Energy Solar Buildings
- 24 Compact Thermal Energy Storage: Material Development for System Integration

The **Solar Heating and Cooling Programme** was one of the first IEA Implementing Agreements to be established. Since 1977, its members have been collaborating to advance active solar and passive solar and their application in buildings and other areas, such as agriculture and industry.

A total of 41 Tasks have been initiated, 32 of which have been completed. Each Task is managed by an Operating Agent from one of the participating countries. Overall control of the program rests with an Executive Committee comprised of one representative from each contracting party to the Implementing Agreement. In addition to the Task work, a number of special activities—Memorandum of Understanding with solar thermal trade organizations, statistics collection and analysis, conferences and workshops—have been undertaken.

### CURRENT MEMBERS

Australia  
Austria  
Belgium  
Canada  
Denmark  
European Commission  
New Zealand  
Germany  
Finland  
France  
Italy  
Mexico  
Netherlands  
Norway  
Portugal  
Spain  
Sweden  
Switzerland  
United States

## INTRODUCTION

This report highlights the recent accomplishments of the IEA Solar Heating and Cooling Programme.

As illustrated throughout the booklet, the SHC Programme's work continues to be driven by our vision of increasing the use of solar designs and technologies in the built environment, and for agricultural and industrial process heat.

Solar technologies can supply energy for all building applications—heating, cooling, hot water, light and electricity—without the harmful effects of greenhouse gas emissions created by conventional energy sources. Solar technologies are appropriate for all building types—single-family homes, multi-family residences, office and industrial buildings, schools, hospitals, and other public buildings—and are applicable anywhere in the world. Active solar technologies can also be used for agricultural and industrial process heat applications.

Solar thermal's impact continues to grow—at the end of 2006, the solar thermal capacity in operation globally reached 127.8 GWth, that is 182.5 million square meters of collector area. Compared with other forms of renewable energy, solar heating's contribution in meeting global demand is, besides the traditional renewables like biomass and hydropower, second only to wind.

By highlighting our work and collaborating with others, the SHC Programme hopes to increase awareness of solar thermal energy's potential to contribute significantly to the future supply of energy worldwide.

Doug McClenahan  
SHC Chairman

Total Capacity in Operation

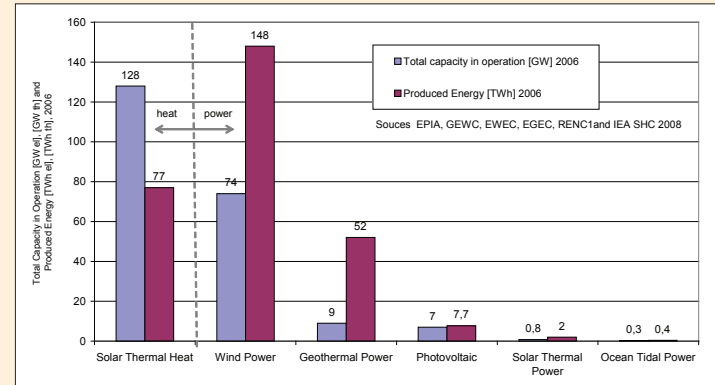

Source: IEA SHC Solar Heat Worldwide should put year of publication, 2008 Edition.

# Advanced Storage Concepts for Solar and Low Energy Buildings

## PARTICIPATING COUNTRIES

Austria  
Denmark  
France  
Germany  
Netherlands  
Spain  
Sweden  
Switzerland

## THE ISSUE

Market demand for low energy houses (homes that use 40–45 kWh/m<sup>2</sup> per year for space heating) that include solar for heating is growing exponentially. Examples flourish in Germany with the “Passiv Haus” concept, in Switzerland with “Minergie”, and in France with the “building with positive energy” concept.

However, an efficient and cost effective means to store solar energy for heating during the winter months and for cooling during the summer months remains a challenge.

## OUR WORK

The objective of *SHC Task 32: Advanced Storage Concepts for Solar and Low Energy Buildings* was to investigate new and advanced solutions for storing thermal energy to use in the heating and cooling of buildings. To do this, the Task participants contributed to the development of advanced storage solutions to reach high solar

fractions in buildings, up to 100% in a typical 45N latitude climate. The Task’s overall goal was to integrate advanced storage concepts in a thermal system (solar, heat pump or boiler) to use in low energy buildings rather than develop new storage systems.

Task 32 was a five-year project that ended in December 2007.

## KEY RESULTS

### Water Tank Storage

Water tank storage is the state-of-the-art choice for solar combisystems, but improvements are needed in tank efficiency and in the overall performance of water-based combisystems.

One technology used to improve tank efficiency is a stratifier. This technology is used to improve the overall temperature of hot water in a tank so that less auxiliary heat is needed. There are several devices currently on the market, but all are fairly complicated and expensive. As part of SHC Task 32,

a simple device made of fabric was developed and tested in Denmark. It has exhibited promising results compared to the current devices. Does a stratifier make a difference? Denmark investigated three combisystem configurations with the only variation being the stratification scheme in the water tank. The system using two stratification devices, one for the solar loop and one for the return loop, performed best— a 20% improvement in the annual solar energy delivered to the load in the best case compared to the no stratifier scenario.

### Storage with Phase Change Materials (PCM)

SHC Task 32 demonstrated that PCMs used in a water storage tank can improve the overall annual performance of a solar combisystem. Sodium acetate with graphite is a good candidate due to its transition temperature at 58° C. However, at this time the improvement to the system’s performance by using sodium

acetate is not great enough to cover the higher investment cost.

Other materials such as commercially available PCMS, with a temperature change around 35° C placed in the bottom of a tank were found to be even more interesting than sodium acetate, but requires further investigation.

### Sorption Storage

This type of storage technology is based on the ability of sorption materials to release water vapor when heated and to release heat when the water vapor is adsorbed or absorbed. For example, during the summer the heat produced by solar collectors would dry up the material, and in the winter water would be put back onto the surface of the material to release the heat for use.

A new method for using extruded solid zeolite with air channels showed interesting properties in the laboratory at the Institute of Thermal Engineering in Germany. Simulations demonstrated that

an 8 m<sup>3</sup> storage volume would be enough for 70% of the heating load of a low energy house. A laboratory prototype will deliver more information in 2008.

The Swiss Federal Laboratories for Materials Testing and Research (EMPA) built a storage unit prototype based on sodium hydroxide desorption at 150° C. First results show that the material can dry in the summer even better than anticipated (65% concentration reached) reducing the needed charging temperature to 120°C. It is anticipated that a 10 m<sup>3</sup> storage unit could deliver all the heating needs of a low energy house during the winter, but the process requires a low grade temperature heat source such as a borehole in the ground. The pilot installation is being monitored over the next two years.

### Storage with Chemical Reactions

The high density of storage with chemical reactions makes this topic attractive, however, before a

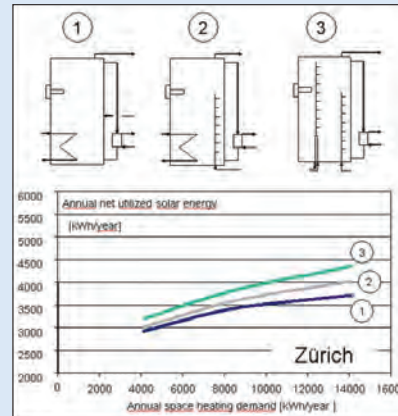

Detailed simulations from the Technical University of Denmark (DTU) demonstrated that the best solution in a Zürich climate was clearly the double stratifier.

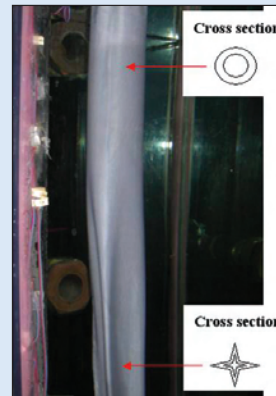

The fabric stratifier for water tank storage developed by the Technical University of Denmark (DTU).

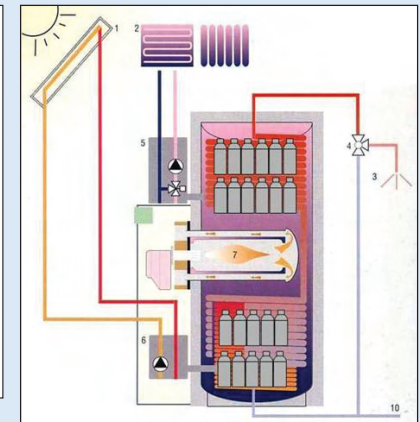

A combisystem with a water storage tank filled with bottles of PCM was tested and simulated at HEIG-VD in Switzerland.

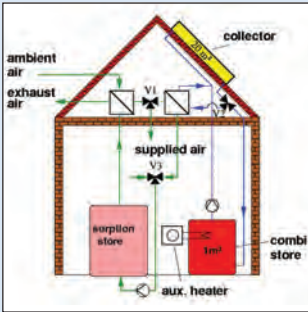

The monosorp storage concept from the Institute of Thermal Engineering (ITW, University of Stuttgart) in Germany.

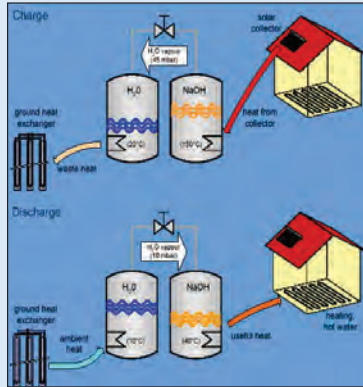

The principle of a NaOH / H<sub>2</sub>O storage system tested at EMPA in Switzerland.

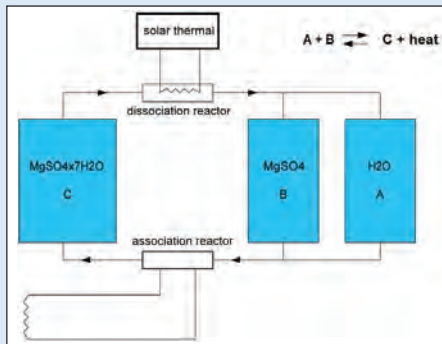

Sketch of a future chemical heat store system with its three vessels proposed by ECN of the Netherlands.

product is available commercially many barriers must be overcome.

The choice of an adequate reaction has kept the attention of the Energy Research Centre of the Netherlands (ECN). A promising material is magnesium hydroxide seven hydrates, which could theoretically store 777 kWh/m<sup>3</sup> at 122°C, a factor 10 compared to the 77 kWh/m<sup>3</sup> for water between 30°C and 100°C. The principle is to dry the material in summer with solar heat and in winter re-hydrate it to deliver back the energy. Work with this material and its ability to de-hydrate and re-hydrate is only at the beginning stage.

Project Date: 2003-2007

Project Leader: Jean-Christophe Hadorn of Groupe Berney - BASE Consultants SA, Switzerland, e-mail: [jchadorn@baseconsultants.com](mailto:jchadorn@baseconsultants.com)

Publications: <http://www.iea-shc.org/task32/publications/index.html>

# Solar Heat for Industrial Processes

## PARTICIPATING COUNTRIES

Australia  
Austria  
Germany  
Italy  
Mexico  
Portugal  
Spain

## THE ISSUE

The industrial sector has the highest energy use in OECD countries at about 30%, closely followed by the transport sector. At this time, the use of solar energy in this sector is nominal, but the potential is high.

The major share of the energy needed by commercial and industrial companies for their production processes and the heating of their factories is below 250°C. The many applications requiring temperature levels below 80°C can easily be met using solar thermal collectors already on the market. For those applications requiring higher temperatures up to 250°C will require the development of high performance solar collectors and system components.

At this time, there are about 90 solar thermal plants for process heat reported worldwide, with a total installed capacity of about 25 MWth (35,000 m<sup>2</sup>). The potential is much greater though – according to a Task study the potential for the

EU25 countries alone is 100-125 GWth.

## OUR WORK

The objective of *SHC Task 33: Solar Heat for Industrial Processes* was to build solar thermal plants for industrial process heat. To reach this goal, studies on the technology's potential were conducted in the participating countries, medium-temperature collectors were developed for the production of process heat up to temperature levels of 250°C, and solutions were sought to the problems of integrating the solar heat system into industrial processes. In addition, demonstration projects were realized in cooperation with the solar industry.

Task 33 was a four-year collaborative project with the IEA's SolarPACES Programme that ended in October 2007.

## KEY RESULTS

### Potential for Solar Process Heat and Existing Plants

As illustrated in the table, the prime areas for solar heat plants are in the food and beverage industries, the textile and chemical industries, and the simple cleaning industries such as car washes. These are key industries because they require low processing temperatures (30°C - 90°C), and therefore flat-plate solar collectors can be used to not only provide the process heat, but also to heat the production halls.

To provide heat for industrial processes in the temperature range of 80°C - 250°C, three categories of process heat collectors are being developed and tested:

- ▶ Improved flat-plate collectors with double anti-reflecting glass and noble gas filling,
- ▶ Low concentrating flat-plate collectors (CPC collectors), and
- ▶ High concentrating collectors like small parabolic trough collectors or linear Fresnel collectors.

Plant & Country	Application	Installed Capacity & Collector Type	Monitoring Data Available
Contank, Spain	Container washing	357 kW <sub>th</sub> (510 m <sup>2</sup> ) flat plate collector	Yes
ROBUR, Italy	Cooling	65.5 kW <sub>th</sub> (132 m <sup>2</sup> ) Fresnel collector	Yes
Seawater desalination Gran Canaria, Spain	Seawater desalination	70 kW <sub>th</sub> (100 m <sup>2</sup> ) anti-reflective double glazed flat plate collector	Yes
Seawater desalination plant, Jordan	Seawater desalination	50.4 kW <sub>th</sub> (72 m <sup>2</sup> ) flat plate collector	Yes
Fruit juices Gangl, Austria	Pasteurizing bottle washing	42 kW <sub>th</sub> (60 m <sup>2</sup> ) flat plate collector	Yes
Sunwash, Austria	Car wash	30 kW <sub>th</sub> (43 m <sup>2</sup> ) flat plate collector	No
Moguntia Spices, Austria	Cleaning and washing processes	152 kW <sub>th</sub> (217 m <sup>2</sup> ) flat plate collector	No
Brewery Neuwirth, Austria	Brewing process	14 kW <sub>th</sub> (20 m <sup>2</sup> ) anti-reflective double glazed flat plate collector	Yes
New Energy Partners, Australia	Cooling	50 m <sup>2</sup> parabolic trough collector	Yes

### Integration of Solar Heat into Industrial Processes

A challenge for this technology is to integrate the solar heat into the industrial process itself. To do this, the temperature of the available heat, the variability of solar radiation, and the heat profile required by the industrial process must all be considered.

To address this challenge, more than 20 system concepts and a "matrix of indicators" were used to create a comprehensive database to serve as a decision support tool for solar experts.

In addition, Task worked focused on the reuse of the excess heat generated during production. The computer program Pinch Energy Efficiency (PE<sup>2</sup>) developed within Task 33 can calculate the heat recovery potential and design



a technically and economically feasible heat exchanger network to optimise the heat recovery for a given process. The remaining heat demand is then partially or completely met using solar thermal energy.

### Demonstration Plants

To demonstrate solar's contribution, nine pilot systems were designed and installed in close cooperation with industry.

### Publications

The final Task results are summarized in four booklets:

- ▶ Potential of solar heat for industrial processes,
- ▶ Process heat collectors,
- ▶ Design guidelines for space heating of factory buildings, and
- ▶ Pilot projects for solar thermal plants in industry.

In addition, a CD was published with:

- ▶ A demo version of the Pinch Energy Efficiency - PE<sup>2</sup> computer program, and
- ▶ The matrix of industrial process indicators.

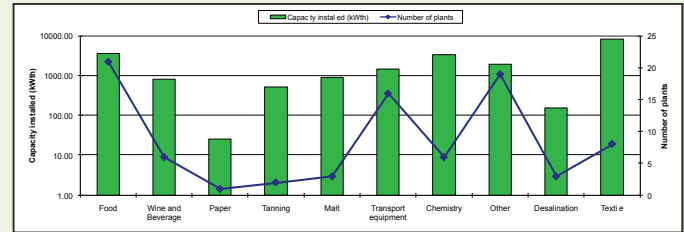

Solar industrial process heat plants by industry sector.



Three of the 12 process heat collectors that were developed or investigated within SHC Task 33. Round Robin tests were carried out at three test centers in Germany and Portugal.



Contank plant for container washing, Barcelona, Spain. Installed capacity: 357 kWh.

(Source: Aiguasol Engineering, Spain).

Project Date: 2003-2007

Project Leader: Werner Weiss of AEE, Institute for Sustainable Technologies, Austria, e-mail: w.weiss@ae.at

Publications: <http://www.iea-shc.org/task33/publications/index.html>

# 34

## Testing and Validation of Building Energy Simulation Tools

### PARTICIPATING COUNTRIES

Australia  
Belgium  
Canada  
Denmark  
France  
Germany  
Ireland  
Japan  
Netherlands  
Sweden  
Switzerland  
United Kingdom  
United States

### THE ISSUE

Innovative low-energy buildings attempt to be highly energy efficient by using innovative energy-efficiency technologies or a combination of innovative energy efficiency and solar energy technologies. To determine the estimated energy savings and reduction in CO<sub>2</sub> emissions, estimates are often evaluated using building energy simulation tools. As with any software tool, accuracy is critical.

### OUR WORK

The objective of *Task 34: Testing and Validation of Building Energy Simulation Tools* was to undertake pre-normative research to develop a comprehensive and integrated suite of building energy analysis tool tests that could provide software quality assurance. To accomplish this, the Task participants investigated the availability and accuracy of building energy analysis tools and engineering models used to evaluate the performance of

innovative low-energy buildings. Activities included the development of analytical, comparative and empirical methods for evaluating, diagnosing and correcting errors in building energy simulation software.

Task 34 was a four-year collaborative project with the IEA's Energy Conservation in Buildings and Community Systems Programme that ended in December 2007.

### KEY RESULTS

#### Software

This work has led to direct improvements in software tools used for evaluating the impacts of energy efficiency and solar energy technologies commonly applied in innovative low-energy buildings. Specifically, the Task identified 63 results disagreements that led to 58 software fixes. This improved accuracy in simulation models has increased confidence in their use by architects and engineers who rely on building energy simulation tool calculations to perform their work.

### Research

The Task's tool evaluation research is linked to the needs and recommendations of the world's leading building energy analysis tool developers. A recent study comparing 20 whole-building energy simulation tools indicated that 19 of the 20 tools reviewed had been tested with at least one of the SHC's IEA BESTEST procedures; 10 of the tools had been tested with more than one of the BESTEST procedures. The study also indicated that test procedures developed by the SHC Programme dominated the set of available tests.

### Codes & Standards

National and international building energy standards organizations have used test cases developed in this Task and earlier SHC Tasks to create standard methods of tests for building energy analysis tools used for national building energy code compliance. Examples include:

- ▶ ANSI (American National Standards Institute) and

ASHRAE (American Society of Heating, Refrigeration, and Air Conditioning Engineers) adopted SHC software validation work into their standards.

- ▶ Several EU countries, as part of the building energy performance assessments under the European Community's Energy Performance Directive, use software tools that have been

checked with IEA BESTEST.

- ▶ CEN used IEA BESTEST to check their reference cooling load calculation general criteria.
- ▶ Australia and New Zealand referenced IEA BESTEST in their codes and standards.
- ▶ Researchers translated previous IEA BESTEST work into Dutch, German, and Japanese.

### A Noteworthy Quote from a Participant/Software Developer

Jeff Thornton, President of Thermal Energy System Specialists (TESS) in Madison, Wisconsin, U.S. – a private-sector company that develops and sells TRNSYS and does consulting work using TRNSYS – published the following comment in his modeler report for one of the subtasks within this Task:

*"Without this IEA subtask for ground coupling, we would have had no means to check the results from our model, nor had a reason to make improvements to our model. There should be no question that the IEA subtask has improved the TRNSYS ground coupling model and, in doing so, has also provided energy modelers a greatly increased sense of confidence when modeling heat transfer to the ground."*

Project Date: 2003-2007

Project Leader: Ron Judkoff of the National Renewable Energy Laboratory, United States, e-mail: [ron\\_judkoff@nrel.gov](mailto:ron_judkoff@nrel.gov)

Publications: <http://www.iea-shc.org/task34/publications/index.html>



Two of the Task's test facilities, the EMPA Test Cells in Duebendorf, Switzerland (on the left) and the Aalborg University Double-Skin Façade Test Facility in Aalborg, Denmark (on the right).

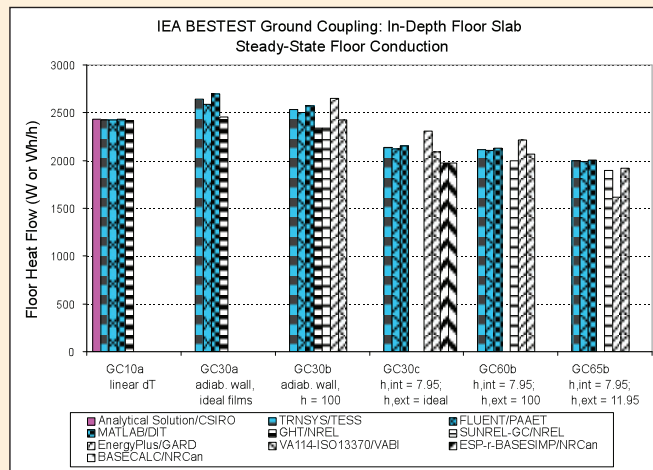

# PV/Thermal Solar Systems

## PARTICIPATING COUNTRIES

Canada  
Denmark  
Hong Kong  
Israel  
Netherlands  
Sweden  
Thailand

## THE ISSUE

Solar collectors that combine photovoltaic (PV) panels and solar thermal collectors to produce both thermal and electric energy are called PV/thermal solar collectors (often referred to as PV/T collectors). By combining these two technologies, PV/T systems are able to generate more energy per unit surface area than side by side PV panels and solar thermal collectors. Calculations made by ECN in the Netherlands show that by using PV/T collectors instead of side-by-side-systems, it is possible to reduce the collector area by 40% and still generate the same amount of energy.

## OUR WORK

The objective of SHC *Task 35: PV/Thermal Solar Systems* was to catalyze the development and market introduction of high quality and commercial competitive PV/thermal solar systems, to increase general understanding of the technology, and to contribute

to internationally accepted standards on performance, testing, monitoring and commercial characteristics of PV/thermal solar systems in the building sector.

Task 35 was a three-year collaborative project with the IEA's Photovoltaic Power Systems Programme that ended in December 2007.

## KEY RESULTS

### Survey

Sixty-five architects and solar dealers from Canada, Denmark, Germany, Italy, Spain, Sweden, and the USA were interviewed to learn what affects the design, purchase, supply and installation of PV/T projects. The main conclusions of the survey were that both architects and solar companies are very interested in PV/T (e.g., for generating publicity and additional business) and that this technology can be used when roof space is limited, can reduce costs due to lower installation costs, and can

be integrated into a building and provide a more uniform appearance than a side-by-side system.

### Collector Testing

The testing of existing PV/T collectors has increased understanding of the collectors' performances, and provided a basis for suggesting standard methods for testing the characteristics and durability of PV/T collectors.

A series of collector tests were conducted at the University of Padova in Italy:

- ▶ Flat plate glazed liquid PV/T collector from PVTWINS in the Netherlands (previously tested at the Danish Technological Institute)
- ▶ Prototype COGEN from Ecosolar Engineering, DTG in Italy
- ▶ Unglazed liquid/air PV/T collector MSS from Millennium Electric in Israel

In addition, a transpired air PV/T collector from Conserva Engineering in Canada, previously

tested at the National Solar Test Facility in Canada, was tested at the Danish Technological Institute. The University of Lund in Sweden also conducted tests on a variety of PV/T collectors.



PV/T test stands at the University of Padova in Italy.



Front and back views of two SolarWall® PV/T transpired air collectors, one thermal reference and one PV reference in the test stand at the Danish Technological Institute.

---

Project Date: 2005-2007, reports will be available November 2008.

Project Leader: Henrik Sørensen of Esbensen Consulting Engineers Ltd., Denmark, e-mail: [H.Soerensen@esbensen.dk](mailto:H.Soerensen@esbensen.dk)

Publications: <http://www.iea-shc.org/task35/publications/index.html>

# Solar Resource Knowledge Management

## PARTICIPATING COUNTRIES

Austria  
Canada  
European Commission  
France  
Germany  
Spain  
Switzerland  
United States

## THE ISSUE

Knowledge of the solar energy resources in a geographical area is critical when designing and building successful solar water heating systems, concentrating solar power systems, and photovoltaic systems. However, good quality measurements of the solar resource are often expensive and scarce, and are time-consuming and costly to acquire. So scientists from around the world are devising ways to assess the solar energy resources using other data sources, such as weather satellite data.

## OUR WORK

The participants in *Task 36: Solar Resource Knowledge Management*, who represent research institutions and private consultancies from around the world, are engaged in producing information products on solar energy resources that will greatly assist policymakers as well as project developers in advancing renewable energy programs worldwide.

The objective of this work is to provide the solar energy industry, the electricity sector, governments, researchers, and renewable energy organizations and institutions with the most suitable and accurate information on solar radiation resources at the Earth's surface in easily-accessible formats and understandable quality metrics. The scope of solar resource assessment information includes historic data sets, currently-derived data products using satellite imagery and other means, and short-term and long-term solar resource forecasts

Task 36 is a five-year collaborative project with IEA's SolarPACES and Photovoltaic Power Systems Programmes that will be completed in June 2010.

## KEY RESULTS

### "Benchmarking" Solar Assessments

Work is underway to benchmark satellite-derived solar data sets developed by different

organizations with each other as well as with highly-qualified ground data sets. Specific procedures based on RMSE, MBE and Kolmogorov-Smirnov statistics have been established by Task team members.

Figure 1 provides an example of how one database, NASA's worldwide Shortwave Surface Radiation Budget, is being benchmarked against a well-known and scientifically validated surface monitoring network known as the Baseline Surface Radiation Network (BSRN).

The National Solar Radiation Database for the U.S has been updated (see Figure 2). This data base makes use of satellite-derived solar assessment techniques that will be included in the Task 36 benchmarking procedures. In addition, the database will be offered through a web-based interactive portal that is underdevelopment as a key component of Task 36.

## Solar Radiation Data

The PVGIS website, established by the Task participant - Joint Research Center in Ispra, Italy, which is an easy-to-use interactive application that provides free access to solar resource data for Europe, Africa, and southwestern Asia, as well as ambient temperature data for Europe. The PVGIS site also provides assessment tools that calculate solar radiation for fixed and sun-tracking systems, calculations of energy output for grid-connected PV systems, and the performance of stand-alone PV systems (Africa only). Tools on the web site provide the user with key overview information on investment decisions to support project

developers and the manufacturing industry. The applications are based on the Google Maps interface and provide several different formats of information, including the estimated accuracy of the calculations. Web-based estimates for single sites can be accessed through the following URL: <http://re.jrc.ec.europa.eu/pvgis/apps3/pvest.php>. In addition, grid formatted data sets at approximately 10-km by 10-km resolution can also be accessed. An example of the PVGIS interface is shown in Figure 3.

Project Date: 2005-2010

Project Leader: David Renné of the National Renewable Energy Laboratory, United States, e-mail: [david\\_renne@nrel.gov](mailto:david_renne@nrel.gov)

Publications: <http://www.iea-shc.org/task36/publications/index.html>

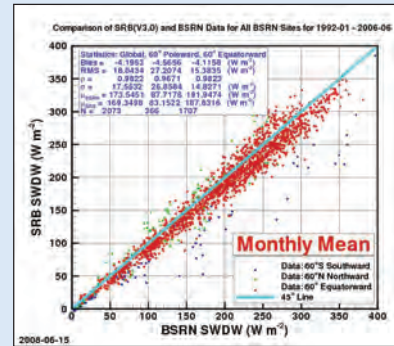

Figure 1. Intercomparison of the NASA Surface Radiation Budget Products for total ground irradiance versus the BSRN precision measurements. (Source: Zhang & Stackhouse, NASA-LaRC).

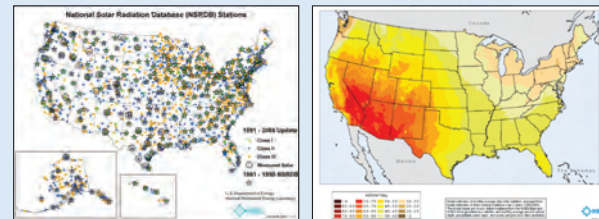

Figure 2. The U.S. 1991-2005 National Solar Radiation Data Base, released in 2007. The left panel shows the location of the 1454 ground stations for which hourly solar radiation were developed. The right panel shows hourly satellite-derived solar radiation data for the years 1998-2005 at a 10-km grid resolution, developed by the State University of New York/Albany for NREL.



Figure 3. Example page from the PVGIS web site (courtesy of Thomas Huld, Marcel Šúri, and Tomáš Cebečaver of the Joint Research Centre, Ispra, Italy).

# 37

## Advanced Housing Renovation with Solar and Conservation

### PARTICIPATING COUNTRIES

Australia  
Austria  
Canada  
Denmark  
France  
Germany  
Italy  
Mexico  
Portugal  
Spain  
Switzerland

### THE ISSUE

Buildings are responsible for up to 35% of the total energy consumption in many of the IEA countries. And, housing accounts for the greatest part of this energy use. Renovating existing housing offers an enormous energy saving potential, and it is the only strategy that can achieve a substantial reduction in energy use in the housing sector in the short-term.

### OUR WORK

The objective of *SHC Task 37: Advanced Housing Renovation with Solar and Conservation* is to develop a solid knowledge base on how to renovate housings to a very high energy standard and to develop strategies that support the market penetration of such renovations. SHC Task 37 focuses on both technical R&D and market implementation.

The Task has begun to analyze the building stock in order to identify building segments with the greatest duplication and energy savings

potential. Examples of building segments are year of construction, type of building, type of envelope and components. Within these segments important topics for discussions are ownership and decision structures, inhabitants and their characteristics, and actual groups of retrofit market players.

In parallel, exemplary renovation projects achieving substantial primary energy savings while creating superior living quality are being analyzed. Important aspects are the energy performance and the owner's motivations behind the renovation.

Insights from this international collaboration will be shared nationally with end users in a deliberate strategy to increase the market penetration of advanced housing renovations.

Task 37 is a four-year collaborative project that will be completed in December 2009.

### KEY RESULTS

Twelve SHC Task 37 demonstration projects show energy reductions from 62-95%, with the average being 75%. Many of these projects include a solar heating system for domestic hot water and/or space heating.





#### Belgium

##### *Rowhouse Henz-Noirfalise*

This 150 year old house needed a thorough renovation. The exterior was insulated with cellulose and new triple glazed windows were installed. The building is heated with solar collectors and a pellet stove. The primary energy use was reduced by 95%.

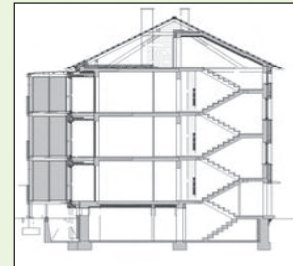

#### Germany

##### *Apartment Building Freiburg*

The renovation of two apartment buildings built in 1961 included additional insulation, new windows, and the addition of solar water heating systems. Primary energy use was reduced by 87% in one building and 80% in the other.



#### Switzerland

##### *Apartment Building Staufen*

The renovation of this apartment happened in two stages—first the building envelop and then the technical systems. System renovations included the addition of an air-water-heat pump, and a 110 m<sup>2</sup> PV installation on the roof with a nominal output of 14.7 kWp to be amortized in 20 years. Primary energy use was reduced 65%.

---

Project Date: 2006-2009

Project Leader: Fritjof Salvesen of KanEnergi AS, Norway,  
e-mail: [fs@kanenergi.no](mailto:fs@kanenergi.no)

Publications: <http://www.iea-shc.org/task37/publications/index.html>

# 38

## Solar Air-Conditioning and Refrigeration

### PARTICIPATING COUNTRIES

Australia  
Austria  
Canada  
Denmark  
France  
Germany  
Italy  
Mexico  
Portugal  
Spain  
Switzerland

### THE ISSUE

Today, solar assisted cooling is most promising for large buildings with central air-conditioning systems. However, the growing demand for air-conditioned homes and small office buildings is opening new sectors for this technology. In many regions of the world, air-conditioning represents the dominate share of electricity consumption in buildings, and will only continue to grow. The current technology, electrically driven chillers, unfortunately do not offer a solution as they create high electricity peak loads even if the system has a relatively high energy efficiency standard.

### OUR WORK

The objective of SHC *Task 38, Solar Air-Conditioning and Refrigeration* is to improve conditions for the market introduction of solar air-conditioning and refrigeration systems for residential and small commercial buildings. This work will be achieved through activities focused on improved components

and system concepts. Participants are working in the areas of pre-engineered systems for residential and small commercial applications, custom-made systems for large non-residential buildings and industrial applications, modeling and analysis, and market dissemination.

Task 38 is a three-year collaborative project that will be completed in August 2009.

### KEY RESULTS

#### Small-Scale Water Chillers

Over the past eight years, a number of small-scale water chillers have been developed by various manufacturers in different countries. To better understand the current market, Task 38 has produced an overview of the available machines, the major technical data and the status of development. The machines use different technologies for cold production, such as absorption with a liquid sorption material,

adsorption with a solid sorption materials, and even thermo-mechanical processes (the novel Rankine cycle).

#### Small-Scale Solar Heating and Cooling Systems

An increasing market for small-scale solar heating and cooling systems can be found for air-conditioning residential houses and small offices. Task 38 will monitor and comparatively evaluate these systems. To date, 18 systems in a range of climate regions have been identified to monitor.

#### Large Non-Residential Buildings and Industrial Refrigeration

Solar air-conditioning technology can also be applied in large non-residential buildings and industrial refrigeration. For this category of systems, Task 38 will carry out a monitoring campaign. To date, 11 systems have been identified to investigate and evaluate. Technologies in these systems include both closed water chillers

and open sorptive cycles – also known as desiccant systems – for direct treatment of fresh air (temperature and humidity control).



These are two examples of the novel small-scale thermally driven cooling machine. On the left is the adsorption chiller from SorTech in Germany. On the right is the water chiller with integrated thermo-chemical storage from Climatewell in Sweden.

---

Project Date: 2006-2009

Project Leader: Hans-Martin Henning of Fraunhofer Institute for Solar Energy Systems, Germany, e-mail: [hans-martin.henning@ise.fraunhofer.de](mailto:hans-martin.henning@ise.fraunhofer.de)

Publications: <http://www.iea-shc.org/task38/publications/index.html>

# 39

## Polymeric Materials for Solar Thermal Applications

### PARTICIPATING COUNTRIES

Austria  
France  
Germany  
Norway  
Portugal  
Sweden  
Switzerland

### THE ISSUE

The economic viability of solar systems for domestic hot water (DHW) production is strongly linked to the cost of the system. An attractive approach to reduce system costs is to replace the glass and metal parts with less expensive, lighter weight polymeric components.

Polymer R&D has lead to numerous new materials, components and manufacturing technologies over the past decades. However, their application in solar technologies is still very limited due to uncertainty in their application and their durability. R&D is needed to realize the full potential of polymers to reduce life-cycle solar energy conversion costs. Polymeric materials can play a key role in the future development of solar energy systems because they offer potentially lower costs, easier processing, lighter weight, and greater design flexibility than materials currently used.

### OUR WORK

The objectives of SHC *Task 39, Polymeric Materials for Solar Thermal Applications* are twofold to access the applicability and the cost reduction potential of polymeric materials and polymer-based novel designs in solar thermal systems and to promote increased consumer confidence in these products by developing and applying appropriate methods to assess their durability and reliability.

SHC Task 39 is a four-year collaborative project that will be completed in September 2010.

### KEY RESULTS

#### State of the Art Report: "Polymeric Materials in Solar Thermal Applications"

A state-of-the-art overview of polymeric materials in solar thermal applications is available at this time to participants in SHC Task 39. The database includes polymeric pool collectors, glazed collectors, small- and medium-size heat stores,

seasonal heat stores and advanced components. It also includes product data sheets and general articles.

### Standards, Regulations and Guidelines

The existing test standards and problems associated with polymer-based systems are under discussion by Task participants. Those active in this work are from prominent test institutions, such as Arsenal Research in Austria, Fraunhofer ISE and ITW-Stuttgart in Germany, INETI in Portugal, and SPF in Switzerland. In addition, several experts have participated in 'norm committees'. Both these create an excellent starting point for influencing revisions of norms which disfavor polymeric collectors/materials. Already Task experts have participated in and shared actions from the Solar Keymark II meeting and the 10th plenary meeting of CEN/TC 312 Thermal Solar Systems and Component.

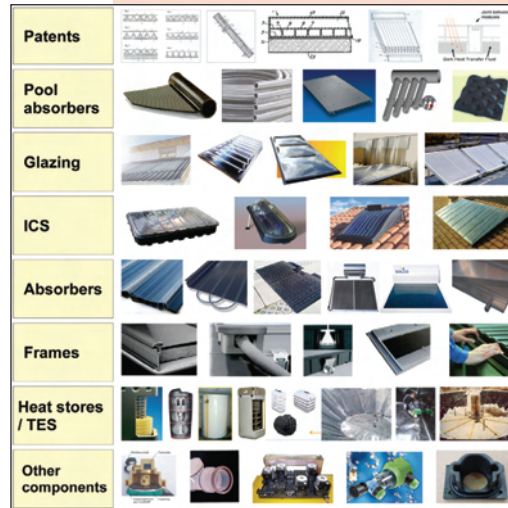

Conventional solar thermal system.



Polymer solar thermal system.

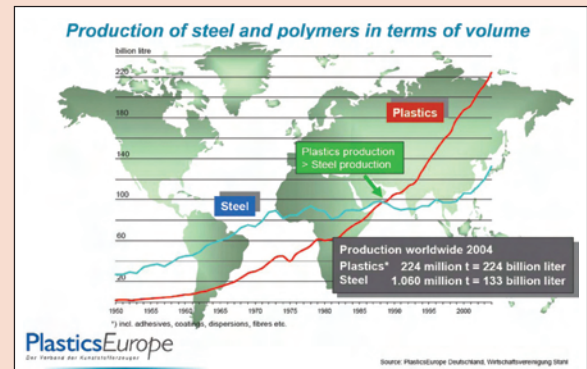

Project Date: 2006-2010

Project Leader: Michael Köhl of Fraunhofer Institute for Solar Energy Systems, Germany, e-mail: michael.koehl@ise.fraunhofer.de

Publications: <http://www.iea-shc.org/task39/publications/index.html>

# 40

## Net Zero Energy Solar Buildings

### THE ISSUE

Energy use in buildings worldwide accounts for over 40% of primary energy use and 24% of greenhouse gas emissions. Energy use and emissions include both direct, on-site use of fossil fuels as well as indirect use from electricity, district heating/cooling systems and embodied energy in construction materials.

Given the global challenges related to climate change and resource shortages, much more is required than incremental increases in energy efficiency. Currently, a prominent vision proposes so called "net zero energy", "net zero carbon" or "Equilibrium" buildings. Although these terms have different meaning and are poorly understood, several IEA countries have adopted this vision as a long-term goal of their building energy policies.

What is missing is a clear definition and international agreement on the measures of building performance that could inform "zero energy"

building policies, programs and industry adoption.

### OUR WORK

The objectives of *Task 40, Net Zero Energy Solar Buildings* are to study current net-zero, near net-zero and very low energy buildings and to develop a common understanding, a methodology, tools, innovative solutions and industry guidelines. The planned outcome of the Task is to support the conversion of the net zero energy building (NZEB) concept from an idea and a "slogan" into practical reality in the marketplace. A source book and data sets developed during the Task will provide realistic case studies of how NZEBs can be achieved.

The scope of the work will include major building types (residential and non-residential, existing and new) in the climatic zones represented by the participating countries. Participants will link the Task work to their national activities and will focus on individual buildings, clusters of buildings and small

settlements. By analyzing existing examples innovative solutions will be developed to be incorporated into the Task's demonstration buildings.

Task 40 is a five-year collaborative project with IEA's Energy Conservation in Buildings & Community Systems Programme. It will begin in October 2008 and end in September 2013.

### EXPECTED RESULTS

The Task's results will be targeted to and designed for the building industry (building manufacturers, manufacturers of components and systems), housing companies and building developers, architects, building engineers and utilities.

Specific results will include:

- ▶ Technical reports on a harmonized methodology and definition and guidelines for monitoring and verification of NZEBs and on the market potential of NZEBs including impacts on grids.

- ▶ Overview of market available and near market NZEB components and systems for different building types and climates.
- ▶ Suite of NZEB tools including a data base and user manual.
- ▶ NZEB source book covering the methodology, technologies, tools, case studies and demonstration projects.
- ▶ Solution sets and designs for national demonstration projects.



Ecoterra EQUilibrium  
Near-Net-Zero Home of  
Alouette Homes in Quebec,  
Canada

Greenstone Low Energy  
Building in Whitehorse, Yukon,  
Canada



Candian Centre for Housing  
Technology in Ottawa, Canada.

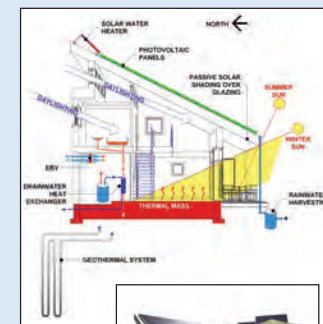

Tsuchiya Twoby Net-Zero-Energy  
Home in Sapporo, Japan



Project Date: 2008-2013

Project Leader: Mark Riley of Natural Resources Canada, e-mail:  
NetZeroBuildings@nrcan.gc.ca

Publications: None at this time.

# 42

## Compact Thermal Energy Storage

### THE ISSUE

By improving the effectiveness of thermal storage, the effectiveness of all renewable energy technologies that supply heat can be improved. For solar thermal systems, it is necessary to store heat (or cold) efficiently for longer periods of time in order to reach high solar fractions, and at this time cost-effective compact storage technologies are not available. For high solar fraction systems, hot water stores are expensive and require very large volumes of space. Alternative storage technologies, such as phase change materials (PCMs) and thermochemical materials (TCMs), are still in the research and development stage.

Around the world, different groups are working on thermal energy storage materials or on applications. However, these activities are not sufficiently linked. The current activities are either limited to specific applications or to specific materials. What is needed,

and what can be provided by the new SHC Task, is a way to bring together the ongoing work on materials and applications.

### OUR WORK

The overall objective of *Task 42, Compact Thermal Energy Storage: Material Development for System Integration*, is to develop advanced materials and systems for the compact storage of thermal energy. A secondary objective is to create an active and effective research network for the collaboration of researchers and industry working in the field of thermal energy storage.

The Task's scope will cover advanced materials for latent and chemical thermal energy storage, excluding materials related to sensible heat storage. Seasonal solar thermal storage will be a primary focus, but as there are many more relevant applications for TES and materials research can not be limited to only one application, the Task will focus on multiple application areas.

Other applications will include cogeneration and tri-generation and heat pumps, building cooling, district heating, industrial waste heat, and concentrated solar power.

Task 42 is a four-year collaborative project with IEA's Energy Conservation through Energy Storage Programme. It will begin in January 2009 and end in December 2012.

### EXPECTED RESULTS

The Task's results will be targeted to and designed for experts and organizations in the materials and applications sectors. For the materials sector, the results will provide a better understanding of existing and new materials for thermal energy storage, new methods and procedures for material and system performance improvement, and a comprehensive overview of the possible applications for this class of materials.



For the applications sector, the results will provide a better understanding of the potential and barriers of compact thermal energy storage materials and systems for their application.

Specific results will include:

- ▶ Materials database with material properties and relations, materials safety data sheets, and samples of new materials for material testing.
- ▶ Inventory of production technologies and materials pricing datasheets.
- ▶ Long-term stability test protocols for several classes of material.
- ▶ Test procedures for model validation and validated numerical models for all applications.
- ▶ System testing methods.
- ▶ Case studies and a field test of a least one application.

Project Date: 2009-2012

Project Leader: Wim van Helden of the Energy Research Center of the Netherlands, e-mail: vanhelden@ecn.nl

Publications: None at this time.

Thermochemical material (magnesium sulphate heptahydrate) being researched at the milligram level.

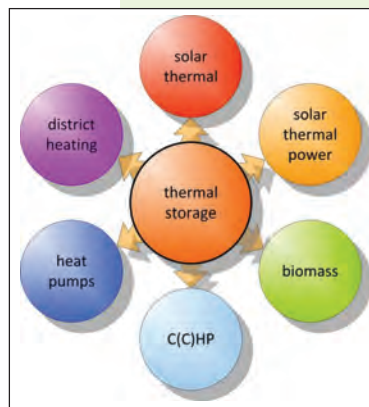
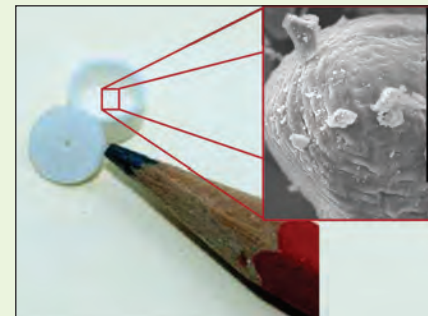

Thermal energy storage is essential for a 100% solar house (Source: ESTIF).

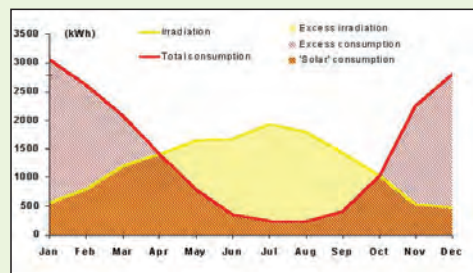

With seasonal storage, the summer's solar heat can be used to meet heating demand in winter.

## SHC Projects & Lead Countries

- Task 1 **Performance of Solar Heating and Cooling Systems**, 1977-83 (Denmark)
- Task 2 **National Solar R & D Programs & Projects**, 1977-84 (Japan)
- Task 3 **Solar Collector and System Testing**, 1977-87 (Germany and United Kingdom)
- Task 4 **Insolation Handbook and Instrumentation Package**, 1977-80 (United States)
- Task 5 **Existing Meteorological Information for Solar Applications**, 1977-82 (Sweden)
- Task 6 **Evacuated Tubular Collector Performance**, 1979-87 (United States)
- Task 7 **Central Solar Heating Plants with Seasonal Storage**, 1979-89 (Sweden)
- Task 8 **Passive Solar Low Energy Homes**, 1982-89 (United States)
- Task 9 **Solar Radiation and Pyranometry**, 1982-91 (Canada and Germany)
- Task 10 **Solar Materials R & D**, 1985-91 (Japan)
- Task 11 **Passive Solar Commercial Buildings**, 1986-91 (Switzerland)
- Task 12 **Solar Building Analysis Tools**, 1989-94 (United States)
- Task 13 **Advanced Solar Low Energy Buildings**, 1989-94 (Norway)
- Task 14 **Advanced Active Solar Systems**, 1990-94 (Canada)
- Task 15 **Advanced Central Solar Heating Plants**, not initiated
- Task 16 **Photovoltaics for Buildings**, 1990-95 (Germany)
- Task 17 **Measuring and Modeling Spectral Radiation**, 1991-94 (Germany)
- Task 18 **Advanced Glazing Materials**, 1991-97 (United Kingdom)
- Task 19 **Solar Air Systems**, 1993-99 (Switzerland)
- Task 20 **Solar Energy in Building Renovation**, 1993-98 (Sweden)
- Task 21 **Daylight in Buildings**, 1995-99 (Denmark)
- Task 22 **Building Energy Analysis Tools**, 1996-03 (United States)
- Task 23 **Optimization of Solar Energy Use in Large Buildings**, 1997-02 (Norway)

- Task 24 **Solar Procurement**, 1998-03 (Sweden)
- Task 25 **Solar Assisted Air Conditioning of Buildings**, 1999-04 (Germany)
- Task 26 **Solar Combisystems**, 1998-02 (Austria)
- Task 27 **Performance of Solar Facade Components**, 2000-05 (Germany)
- Task 28 **Solar Sustainable Housing**, 2000-05 (Switzerland)
- Task 29 **Solar Crop Drying**, 2000-06 (Canada)
- Task 30 **Solar Cities**, not initiated
- Task 31 **Daylighting Buildings in the 21st Century**, 2001-05 (Australia)
- Task 32 **Advanced Storage Concepts for Solar and Low Energy Buildings**, 2003-07 (Switzerland)
- Task 33 **Solar Heat for Industrial Processes**, 2003-07 (Austria)
- Task 34 **Testing and Validation of Building Energy Simulation Tools**, 2003-07 (United States)
- Task 35 **PV/Thermal Systems**, 2005-07 (Denmark)
- Task 36 **Solar Resource Knowledge Management**, 2005-10 (United States)
- Task 37 **Advanced Housing Renovation with Solar & Conservation**, 2006-09 (Norway)
- Task 38 **Solar Air Conditioning and Refrigeration**, 2006-09 (Germany)
- Task 39 **Polymeric Materials for Solar Thermal Applications**, 2006-10 (Germany)
- Task 40 **Net Zero Energy Solar Buildings**, 2008-13 (Canada)
- Task 42 **Compact Thermal Energy Storage: Material Development for System Integration**, 2009-12 (Netherlands)

Notice:

The Solar Heating and Cooling Programme, also known as the Programme to Develop and Test Solar Heating and Cooling Systems, functions within a framework created by the International Energy Agency (IEA). Views, findings and publications Solar Heating and Cooling Programme do not necessarily represent the views or policies of the IEA Secretariat or of all its individual member countries.



[www.iea-shc.org](http://www.iea-shc.org)

To find Solar Heating and Cooling Programme publications and learn more about the Programme visit [www.iea-shc.org](http://www.iea-shc.org) or contact the SHC Executive Secretary, Pamela Murphy, e-mail: [pmurphy@MorseAssociatesInc.com](mailto:pmurphy@MorseAssociatesInc.com).